



**John
BOOS**
Since 1887

ITEM #: _____ QTY: _____
 MODEL #: _____
 PROJECT NAME: _____

090319

3601 S. Banker St. Effingham, IL 62401 • P.O. BOX 609 • Ph: (888) 431-2667 • Fax: (800) 433-2667

"4CH4R5" MODULAR BASE WORK TABLES - 14GA TOP

HINGED DOOR STYLE - 5" BACKSPLASH

FEATURES:

- ENCLOSED BASE WORK TABLES - **HINGED DOOR STYLE**
- **5" BACKSPLASH TOP** WITH 1-1/2" STALLION EDGE ON FRONT AND 90 DEGREE BEND DOWN SIDE EDGE FOR TABLE LINE-UP
- TOP IS SOUND DEADENED REINFORCED WITH 2"X3" CHANNEL RUNNING ENTIRE LENGTH OF TOP
- STAINLESS STEEL LEG WITH ADJUSTABLE FEET
- FIXED OR ADJUSTABLE INTERMEDIATE SHELF AVAILABLE
- 36" WORKING HEIGHT
- SHIPPED STANDARD WELDED SET-UP



4CH4R5-2460

CONSTRUCTION:

- TOP: STAINLESS STEEL CABINET TOPS TIG WELDED, EXPOSED WELDS ARE POLISHED TO MATCH ADJACENT SURFACE #4 POLISHED, SATIN FINISH
- REMOVABLE STAINLESS STEEL LEGS
- HINGED DOORS ARE CONSTRUCTED AS DOUBLE PANEL DOORS



STALLION EDGE

INTERMEDIATE SHELF IS AVAILABLE IN FIXED OR ADJUSTABLE

- FIXED MID SHELF ADD: "-1S"
- ADJ MID SHELF ADD: "-1AS"

MATERIAL:

- TOP: 14GA TYPE 300 STAINLESS STEEL WITH #4 POLISH, SATIN FINISH
- BODY: 18GA TYPE 430 STAINLESS STEEL
- LEGS: STAINLESS STEEL WITH ADJUSTABLE FEET

24" WIDE

MODEL	QTY
4CH4R5-2436	
4CH4R5-2448	
4CH4R5-2460	
4CH4R5-2472	
4CH4R5-2484	
4CH4R5-2496	
4CH4R5-24108	
4CH4R5-24120	
4CH4R5-24132	
4CH4R5-24144	

30" WIDE

MODEL	QTY
4CH4R5-3036	
4CH4R5-3048	
4CH4R5-3060	
4CH4R5-3072	
4CH4R5-3084	
4CH4R5-3096	
4CH4R5-30108	
4CH4R5-30120	
4CH4R5-30132	
4CO4R5-30144	

36" WIDE

MODEL	QTY
4CH4R5-3636	
4CH4R5-3648	
4CH4R5-3660	
4CH4R5-3672	
4CH4R5-3684	
4CH4R5-3696	
4CH4R5-36108	
4CH4R5-36120	
4CH4R5-36132	
4CH4R5-36144	

DETAILED SPECIFICATIONS

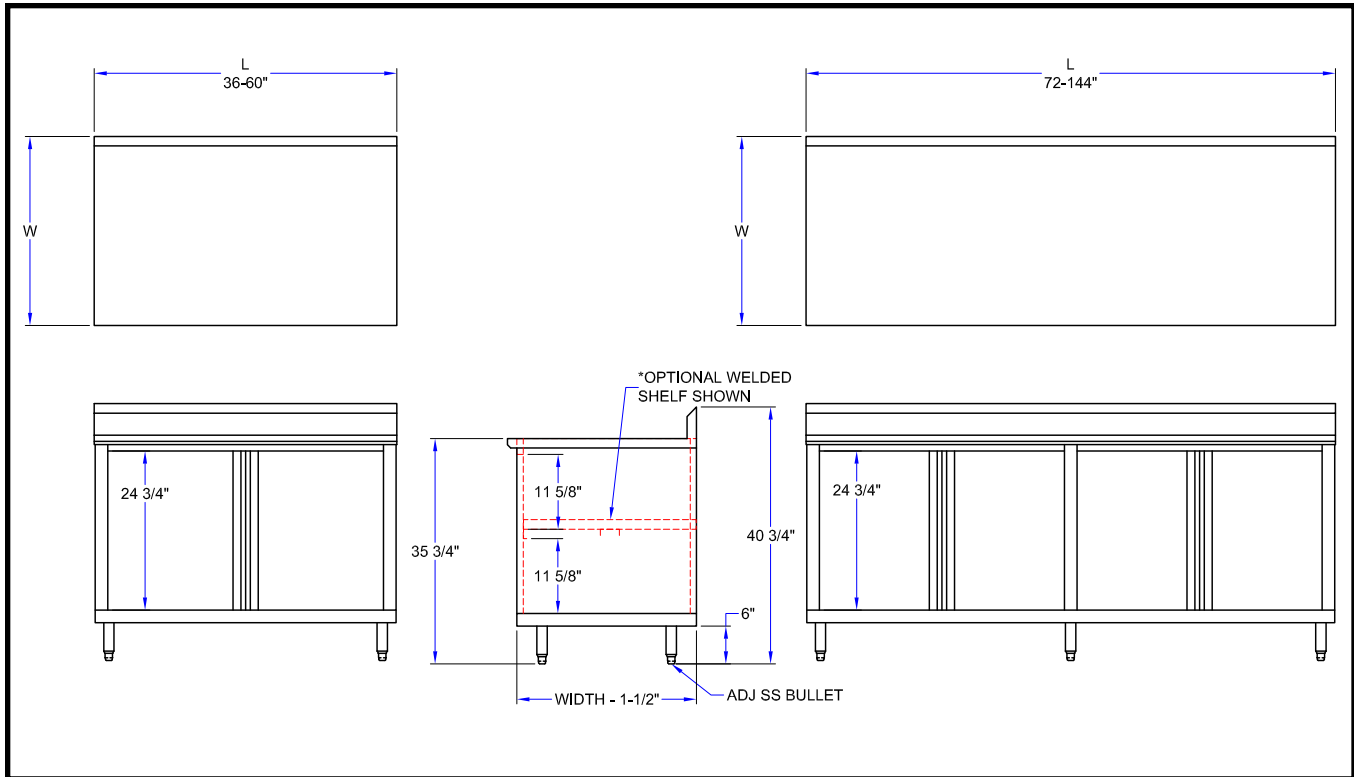

24" WIDE

LENGTH	MODEL	WT. (LBS)
36"	4CH4R5-2436	103
48"	4CH4R5-2448	270
60"	4CH4R5-2460	310
72"	4CH4R5-2472	355
84"	4CH4R5-2484	395
96"	4CH4R5-2496	445
108"	4CH4R5-24108	495
120"	4CH4R5-24120	535
132"	4CH4R5-24132	575
144"	4CH4R5-24144	615

30" WIDE

LENGTH	MODEL	WT. (LBS)
36"	4CH4R5-3036	260
48"	4CH4R5-3048	295
60"	4CH4R5-3060	335
72"	4CH4R5-3072	375
84"	4CH4R5-3084	415
96"	4CH4R5-3096	460
108"	4CH4R5-30108	505
120"	4CH4R5-30120	550
132"	4CH4R5-30132	593
144"	4CO4R5-30144	635

36" WIDE

LENGTH	MODEL	WT. (LBS)
36"	4CH4R5-3636	290
48"	4CH4R5-3648	330
60"	4CH4R5-3660	370
72"	4CH4R5-3672	415
84"	4CH4R5-3684	455
96"	4CH4R5-3696	500
108"	4CH4R5-36108	555
120"	4CH4R5-36120	615
132"	4CH4R5-36132	650
144"	4CH4R5-36144	685

MODEL # STRUCTURE

R = RISER
 4 = 14 GAUGE
 CH = S.S. CABINET HINGED DOORS
 4 = 430 STAINLESS STEEL WRAP

5 = 5" HIGH X 1-1/2" DEEP W/TURN DOWN
 24 = WIDTH - FRONT TO BACK
 36 = LENGTH - LEFT TO RIGHT

4CH4R5-2436

SOME UNITS SHIP UNASSEMBLED FOR REDUCED SHIPPING COST. ALL DIMENSIONS ARE TYPICAL. TOLERANCE +/- .500"

John Boos & Co. is constantly engaged in a program of improving products and therefore reserves the right to change specifications without prior notice.



3601 S. Banker St. • Effingham, IL 62401 • PO BOX 609 • quotes@johnboos.com

090319



www.johnboos.com

512